



TRIBUNAL DE JUSTIÇA DO ESTADO DO AMAZONAS

PREGÃO ELETRÔNICO Nº 011/2021 UASG: 925866

ABERTURA: 03/01/2021 ÀS 10:00 HORAS

**PROPOSTA DE PREÇO**

**DADOS DA EMPRESA**

Razão Social: BRAGAL COMERCIAL E SERVIÇOS LTDA

CNPJ n.º: 32.324.669/0001-25

Inscrição Estadual n.º: 11.331.386

Endereço: RUA FIGUEIRA DE MELO, 258A - SÃO CRISTOVÃO

CEP: 20.941-001 - Cidade: RIO DE JANEIRO / Estado: RIO DE JANEIRO

Fone: (21)2580-3355

E-mail: contato@licitarj.com.br

ITEM	DESCRIÇÃO	MARCA / MODELO	UND	QUANT	PREÇO UNITÁRIO	TOTAL	POR EXTENSO
1	Persianas Verticais Detalhamento do item: Lâminas: Flexíveis, em PVC de 89 mm, com pintura lisa e com furo aparente. Trilhos: Superior em alumínio, dotados de tampas de laterais de acabamento e suporte adequado para fixação na parede/janela ou teto, com sistema manual de recolhimento e controle de luminosidade; Cor: Bege; Com Instalação.	MARCA: IMBRAPE / FABRICANTE: BRAGAL	M <sup>2</sup>	3000	R\$ 77,99	R\$ 233.970,00	duzentos e trinta e três mil novecentos e setenta reais
2	Bandô para Persiana Detalhamento do item: Bandô em alumínio na cor conforme Persiana; Com Instalação.	MARCA: IMBRAPE / FABRICANTE: BRAGAL	M <sup>2</sup>	2000	R\$ 34,49	R\$ 68.980,00	sessenta e oito mil novecentos e oitenta reais
<b>TOTAL DA PROPOSTA:</b>						<b>R\$ 302.950,00</b>	
<b>TOTAL POR EXTENSO DA PROPOSTA:</b>							<b>trezentos e dois mil novecentos e cinquenta reais</b>

Validade da proposta: 60 (sessenta) dias;

Prazo de entrega: 45 (quarenta e cinco) dias corridos;

Dados Bancários: Banco do Brasil; Agência: 3010-4; Conta corrente: 3942-X;

Nos preços acima estão incluídos todos os insumos que o compõem, inclusive as despesas com impostos, taxas, frete, seguros, carga e descarga importação e quaisquer outros que incidam direta ou indiretamente no fornecimento dos materiais desta Licitação;

O fornecimento objeto da presente licitação ocorrerá nos prazos e condições consignadas competentes no termo de Referência;

Condições De Pagamento: Conforme Edital;

Declaro que estou de pleno acordo com todas as condições estabelecidas no edital e seus anexo;

Rio de Janeiro, 09 de Abril de 2021.

  
 MARCO ANTÔNIO CUNHA DA SILVA  
 SÓCIO/DIRETOR  
 RG 078766369 IFP-RJ, CPF n°004.008.037-47.

32.324.669/0001-25  
 BRAGAL COMERCIAL E SERVIÇOS LTDA  
 Rua Figueira de Melo, 258 / 358 - A  
 São Cristóvão - CEP: 20.941-000  
 RIO DE JANEIRO - RJ.

Rua Figueira de Melo, 358 A – São Cristóvão – Rio de Janeiro – RJ – CEP: 20.941-001

Tel: (21) 2580-3355 E-mail: licitacao2019@bragal.com.br

CNPJ: 32.324.669/0001-25



	Branco	Cores Claras	Cores Escuras
<b>Transmissão de Luz</b>	0	0	0
<b>Reflexão de Luz</b>	9	8	3
<b>Absorção de Luz</b>	1	2	7
<b>Controle de Raio UV</b>	10	10	10
<b>Largura da Lâmina</b>	89mm		
<b>Composição</b>	100% PVC		
<b>Estabilidade Dimensional</b>	Excelente		
<b>Toxicidade</b>	Atóxica		
<b>Aplicação</b>	Decoração de residências, escritórios, clínicas e ambientes hospitalares que exigem higiene. Também em ambientes que exigem maior escurecimento como quartos, salas de projeção e home theaters.		

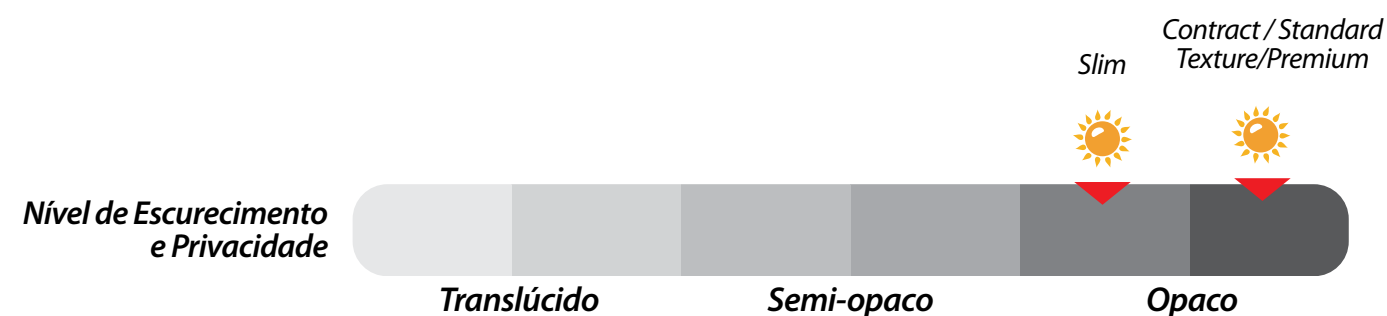

Persiana vertical



Limpeza com pano úmido

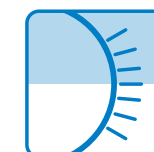

Dim out



Retardante de chamas

# pVc Contract Glossy

Imagens meramente ilustrativas. As cores podem variar de acordo com a calibragem de brilho, contraste e cor de seu monitor.

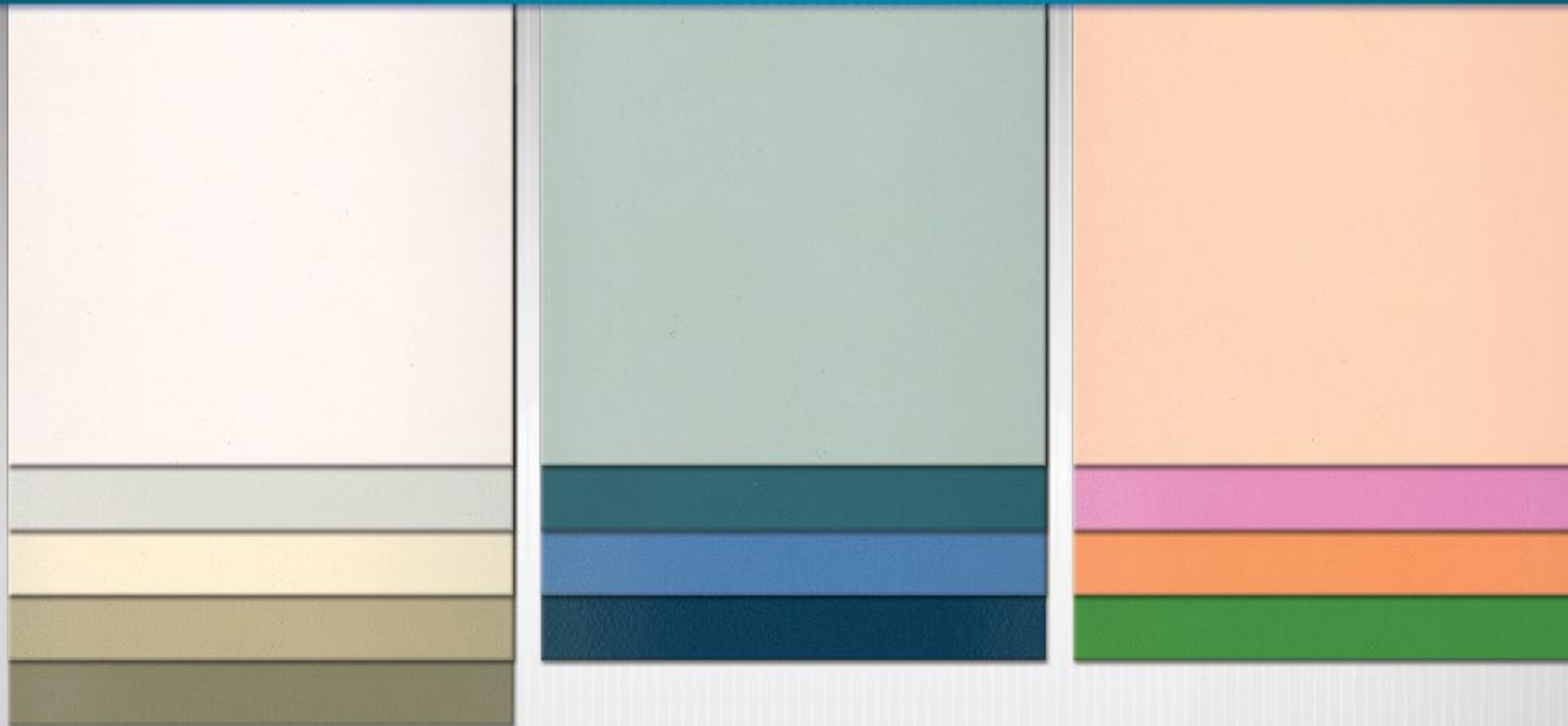

# pVc Contract Glossy



Persiana vertical



Limpeza com pano úmido



Dim out



Retardante de chamas

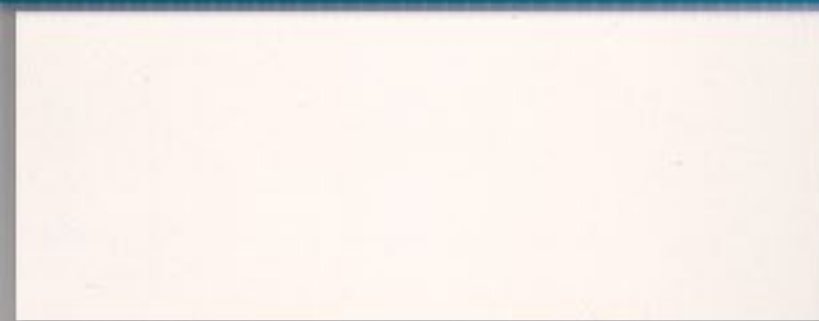

Glossy White

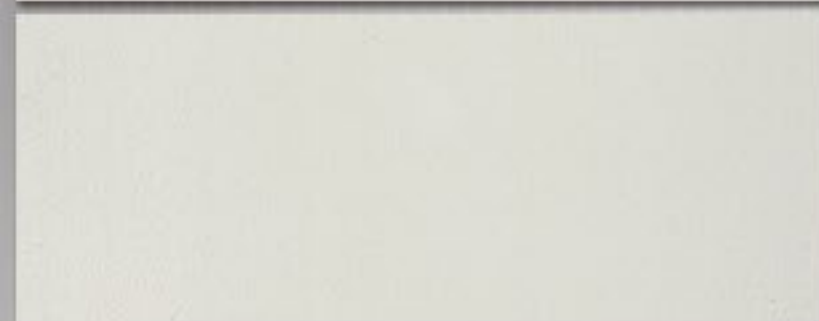

Glossy Gray

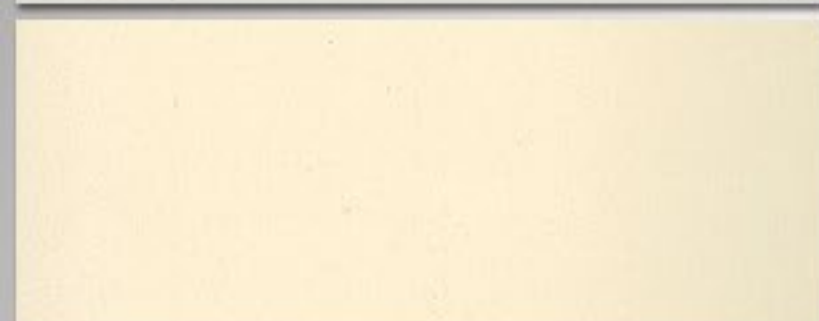

Glossy Ivory



Glossy Café



Glossy Amêndoa

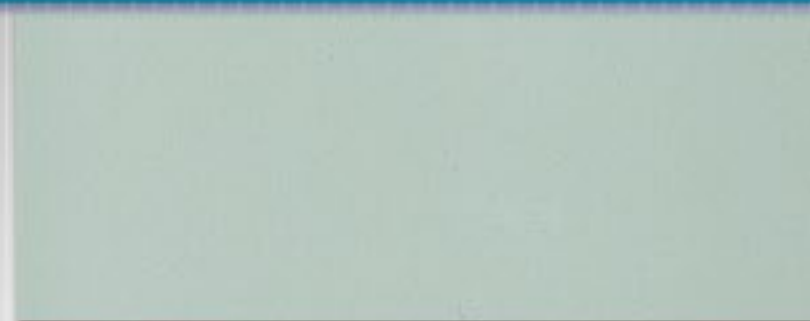

Glossy Steel Blue

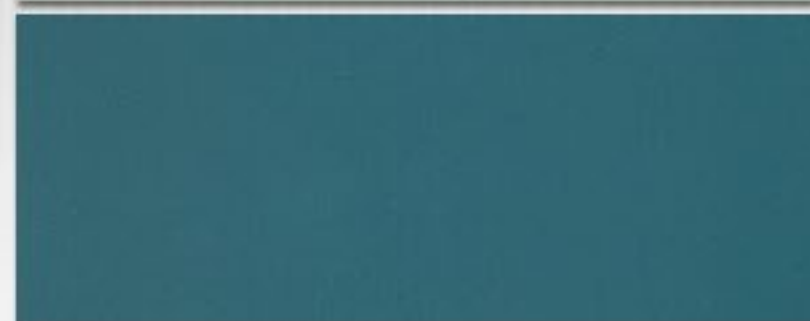

Glossy Sky Blue



Glossy Hortênsia



Glossy Petrol

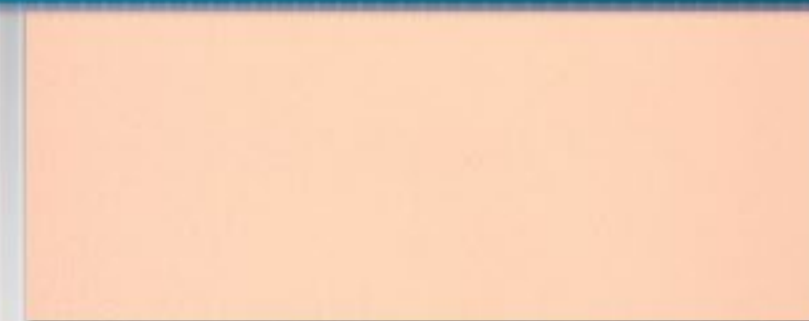

Glossy Apricot



Glossy Rosa



Glossy Papaia



Glossy Limão

# pVc Contract

Imagens meramente ilustrativas. As cores podem variar de acordo com a calibragem de brilho, contraste e cor de seu monitor.

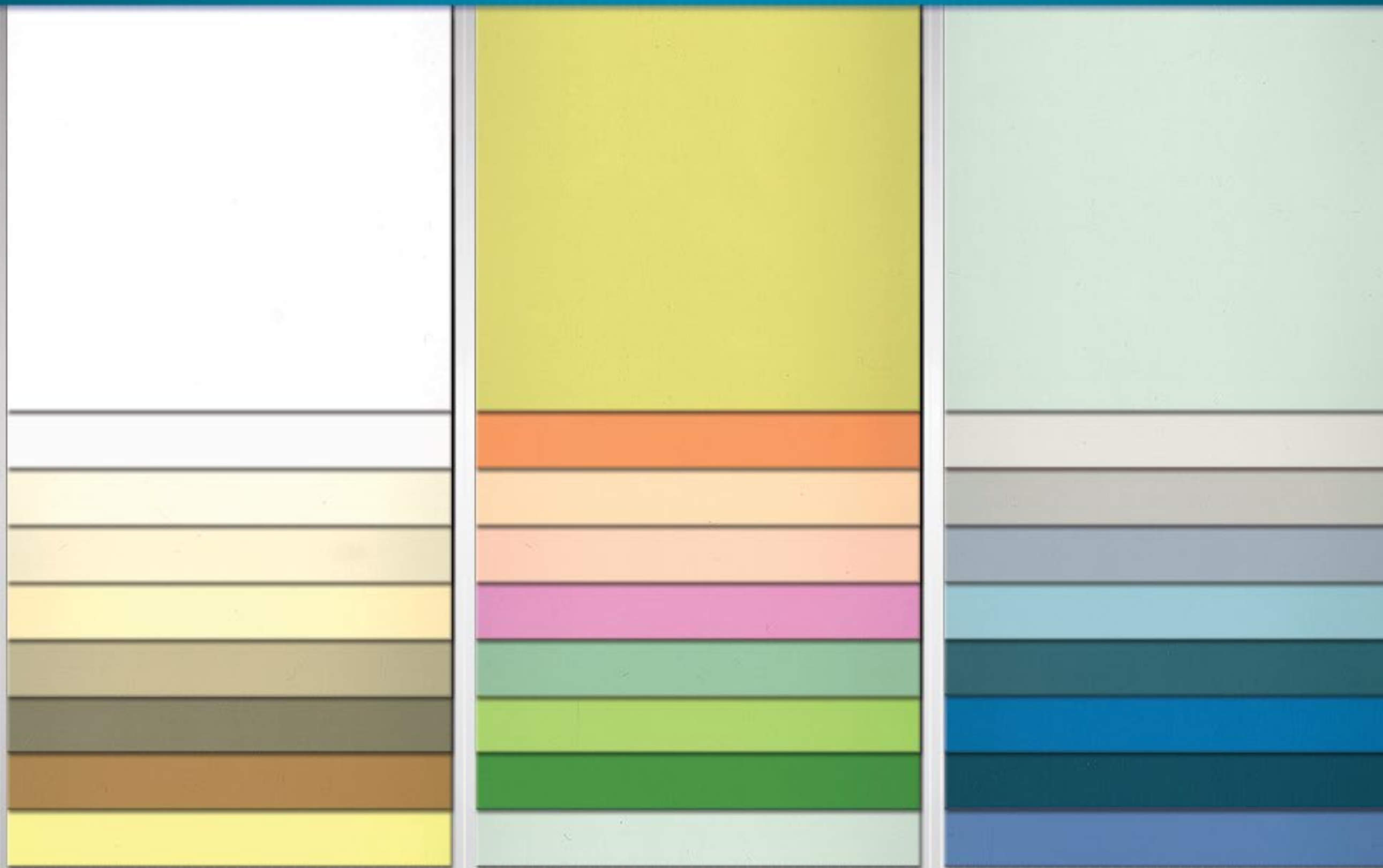



Persiana vertical



Limpeza com pano úmido



Dim out



Retardante de chamas



*Branco Óptico*



*White*

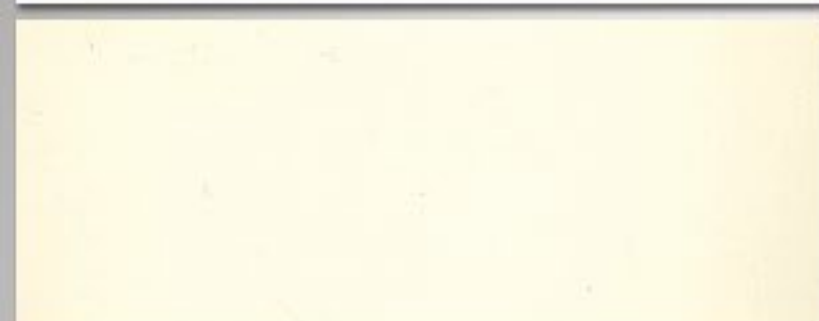

*Ivory*

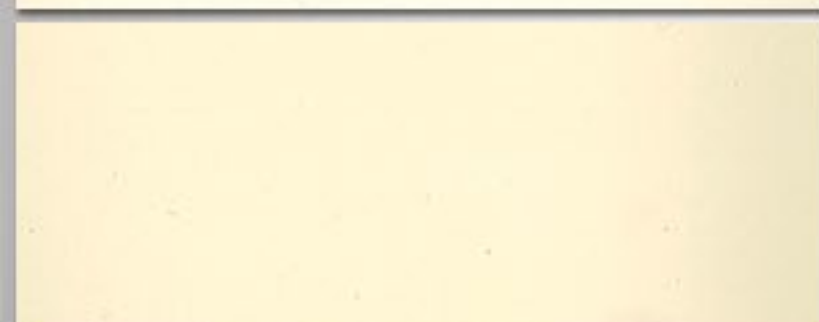

*Tan*



*Vanilla*



*Citrino*

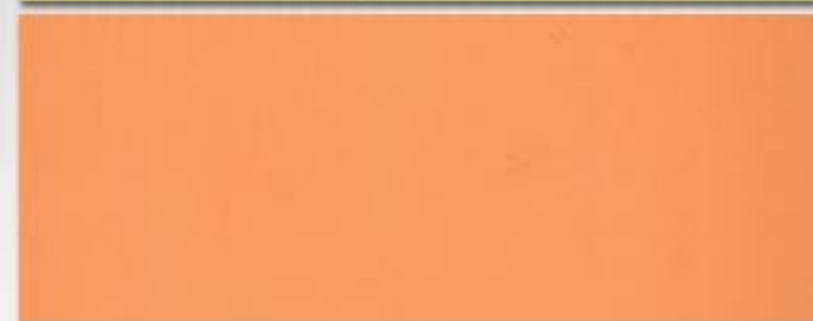

*Papaia*



*Salmão*



*Apricot*



*Rosa*

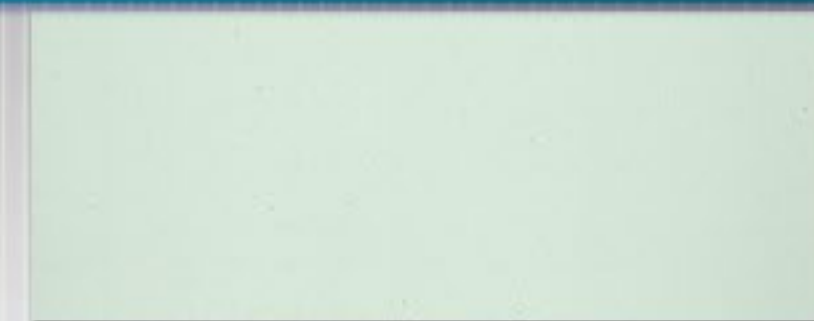

*Steel Blue*

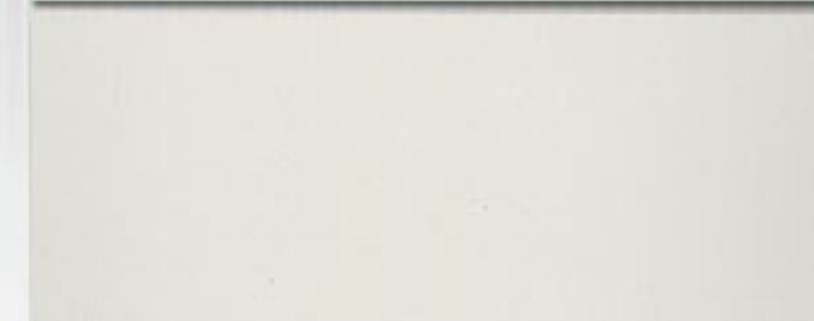

*Gray*



*Dark Gray*

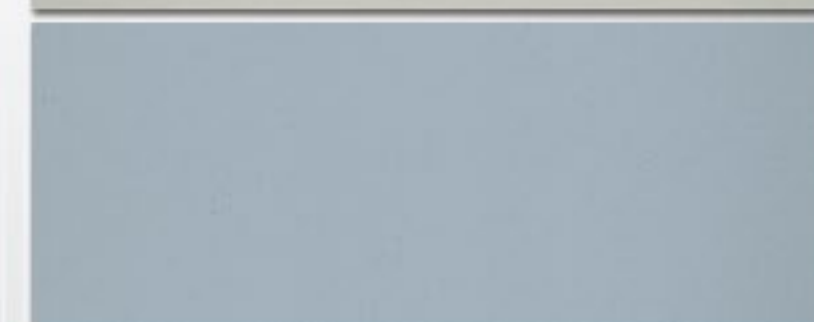

*Lavanda*



*Acqua*



Persiana vertical



Limpeza com pano úmido



Dim out



Retardante de chamas

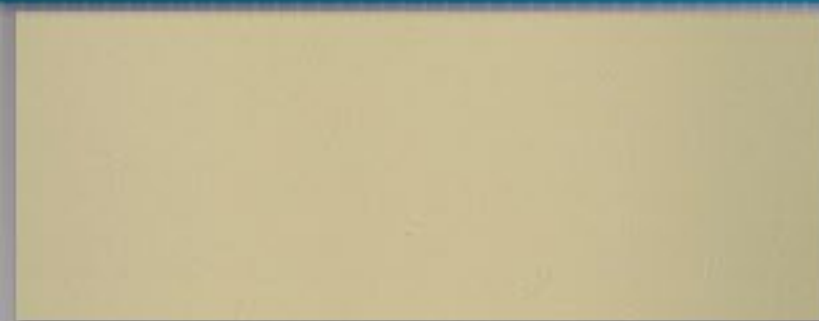

*Café*



*Amêndoa*

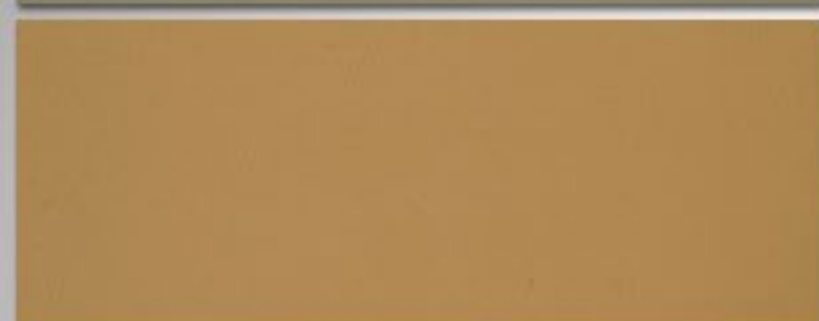

*Caramel*

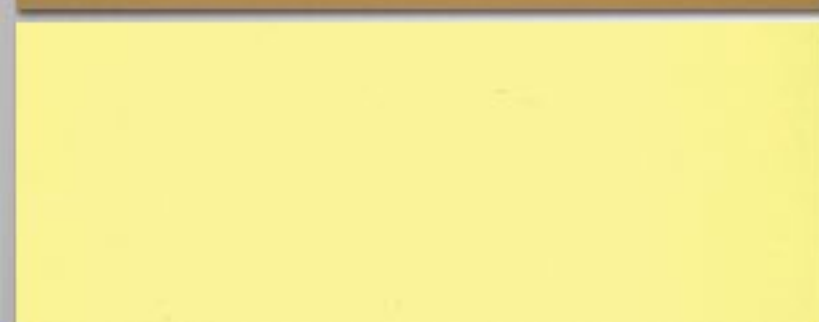

*Lima*



*Pistache*



*Maçã Verde*



*Limão*



*Mint*



*Sky Blue*



*Turquesa*



*Petrol*

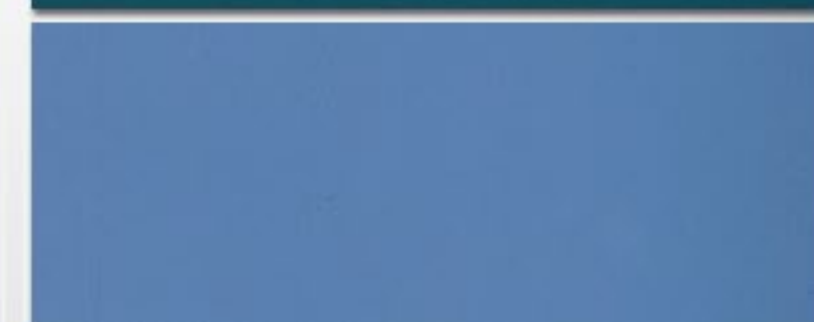

*Hortênsia*

ALPEX-1720  
0,728 Kg/m

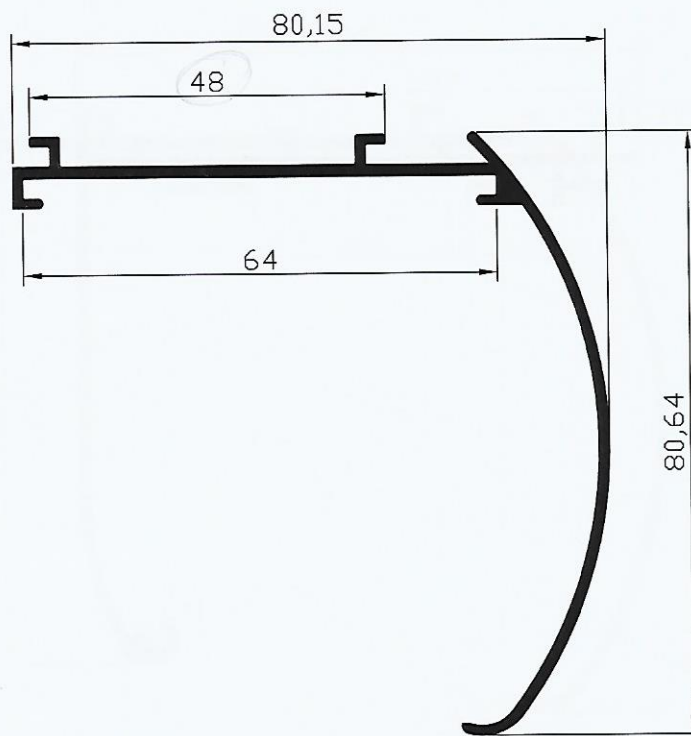

ACESSÓRIOS  
PLASTEC/INJETEC

ALPEX-4586  
0,769 Kg/m

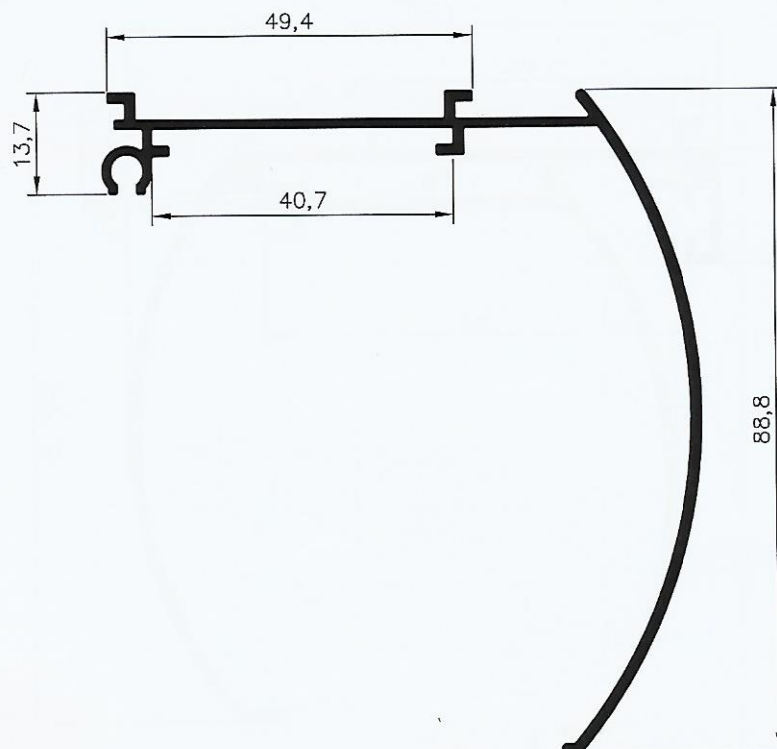

ACESSÓRIOS  
ARCO IRIS